

**PART I**  
**Total Value: 75%**

**Instructions: Shade the letter of the correct answer on the computer scorable answer sheet provided.**

1. What part of a neuron carries nerve impulses towards the cell body?

- (A) axon
- (B) dendrite
- (C) myelin sheath
- (D) Schwann cell

2. Which statement best illustrates homeostasis?

- (A) A constant internal environment is maintained regardless of external change.
- (B) Eyes, ears and nose provide information about the external environment.
- (C) Sensory receptors provide data about whether the body is gaining or losing heat.
- (D) The internal environment of an organism is the same as the external environment.

3. Which structure below controls balance?

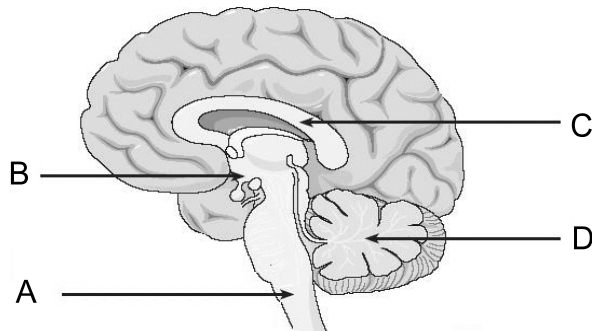

- (A) A
- (B) B
- (C) C
- (D) D

4. Which structure below insulates the neuron?

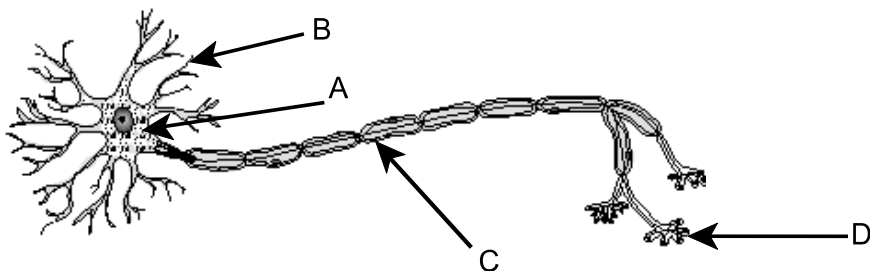

- (A) A
- (B) B
- (C) C
- (D) D

5. Which occurs immediately after an action potential?

- (A) all or none response
- (B) refractory period
- (C) resting potential
- (D) threshold

6. Which sequence occurs after an individual touches a hot object?
- (A) receptor → interneuron → motor neuron → sensory neuron → effector  
 (B) receptor → interneuron → sensory neuron → motor neuron → effector  
 (C) receptor → sensory neuron → interneuron → motor neuron → effector  
 (D) receptor → sensory neuron → motor neuron → interneuron → effector
7. Which is the correct match for a decrease in neurotransmitter production and the disease that results?

	Neurotransmitter	Disease
(A)	acetylcholine	Huntington's Disease
(B)	dopamine	Parkinson's Disease
(C)	GABA	meningitis
(D)	serotonin	multiple sclerosis

8. Which technology measures the electrical activity of the functioning brain and can be used to diagnose epilepsy?
- (A) CAT  
 (B) EEG  
 (C) MRI  
 (D) PET
9. Which structure below regulates the amount of light that enters the eye?

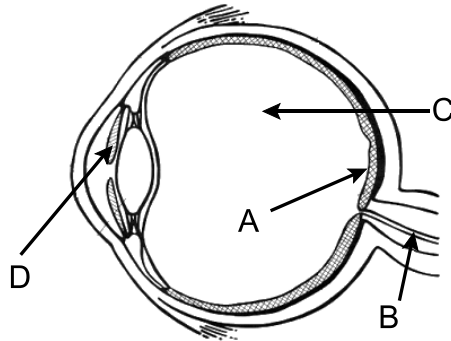

- (A) A  
 (B) B  
 (C) C  
 (D) D
10. Which part of the human ear contains hair cells?
- (A) auditory tube  
 (B) cochlea  
 (C) ossicles  
 (D) semicircular canals

11. In the diagram below, which gland illustrates how the nervous and endocrine systems work together?

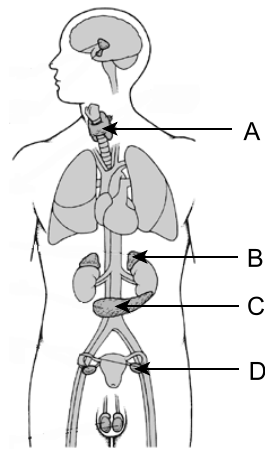

- (A) A  
(B) B  
(C) C  
(D) D
12. Which hormone raises blood sugar?
- (A) adrenaline  
(B) glucagon  
(C) insulin  
(D) thyroxine
13. A person has a swollen neck and experiences fatigue and weight gain. Which would a physician most likely recommend as appropriate treatment?
- (A) increasing dietary intake of calcium  
(B) increasing dietary intake of iodine  
(C) taking insulin injections  
(D) taking vitamin D pills
14. Which hormone stimulates the sympathetic nervous system?
- (A) adrenaline  
(B) glucagon  
(C) somatotropin  
(D) thyroxine
15. Which hormone would a doctor most likely give to an expectant mother to stimulate uterine contractions and induce labour?
- (A) insulin  
(B) oxytocin  
(C) prolactin  
(D) thyroxine
16. In which phase of the cell cycle does DNA replication occur?
- (A) G1  
(B) G2  
(C) M  
(D) S

17. In the diagram below, which structure is indicated by the arrow?

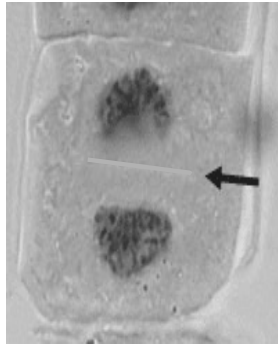

- (A) cell plate  
(B) cell wall  
(C) cleavage  
(D) cytoplasm
18. If a parent cell has 24 chromosomes and undergoes meiosis, how many chromosomes will be found in each new daughter cell?
- (A) 6  
(B) 12  
(C) 24  
(D) 48
19. Why is there only one functional egg cell produced after completion of oogenesis?
- (A) failure of chromatids to separate  
(B) failure of homologous chromosomes to separate  
(C) insufficient amount of genetic material  
(D) unequal division of cytoplasm during meiosis I and II
20. Where are the mitochondria located in a sperm cell?
- (A) acrosome  
(B) head  
(C) middle piece  
(D) tail
21. A queen bee can produce offspring without contribution of sperm. What is this mode of reproduction?
- (A) binary fission  
(B) budding  
(C) parthenogenesis  
(D) spore production
22. Which structure below produces and stores pollen?

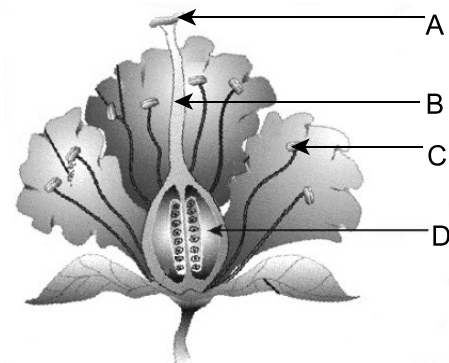

- (A) A  
(B) B  
(C) C  
(D) D

23. Which structure below produces a fluid that neutralizes the acidity of the female reproductive tract?

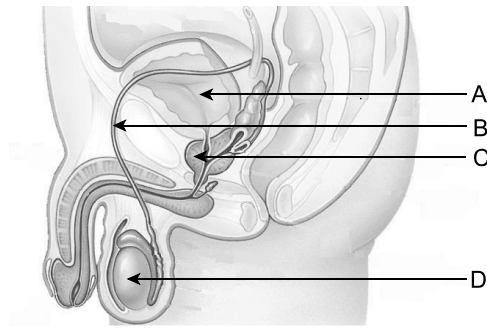

- (A) A  
(B) B  
(C) C  
(D) D
24. Which is stimulated by LH in the male reproductive system?
- (A) FSH  
(B) progesterone  
(C) sperm  
(D) testosterone
25. Ovulation occurs in response to the increase of which hormone?
- (A) estrogen  
(B) FSH  
(C) oxytocin  
(D) progesterone
26. Which sequence represents the normal order of events that occur during the menstrual cycle?
- (A) follicle stage → menstruation → corpus luteum → ovulation  
(B) follicle stage → ovulation → corpus luteum → menstruation  
(C) menstruation → corpus luteum → ovulation → follicle stage  
(D) menstruation → ovulation → corpus luteum → follicle stage
27. Which sexually transmitted infection can lead to infertility?
- (A) chlamydia  
(B) genital herpes  
(C) genital warts  
(D) hepatitis
28. Which side effect of chemotherapy treatments could cause infertility in females?
- (A) blocked oviducts  
(B) damaged eggs  
(C) endometriosis  
(D) failure to ovulate
29. A female who is experiencing difficulty becoming pregnant is prescribed fertility drugs. What hormone is likely to be contained in these drugs?
- (A) estrogen  
(B) FSH  
(C) LH  
(D) progesterone

30. How does an IUD prevent pregnancy?
- (A) prevents the release of FSH and LH
  - (B) prevents implantation
  - (C) prevents sperm from reaching the egg
  - (D) prevents the egg from leaving the Fallopian tube
31. Which refers to the mass of identical cells present during cleavage?
- (A) blastula
  - (B) gastrula
  - (C) morula
  - (D) trophoblast
32. Which organ is most likely affected if the endoderm is damaged during the process of gastrulation?
- (A) brain
  - (B) gonads
  - (C) kidneys
  - (D) lungs
33. Which structure below is the chorion?

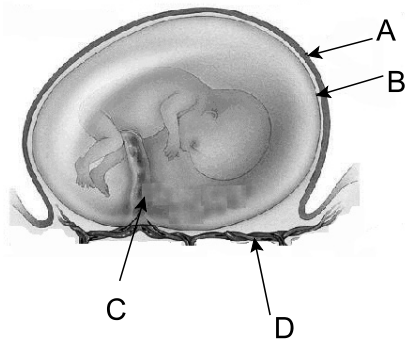

- (A) A
  - (B) B
  - (C) C
  - (D) D
34. Who would be the best donor for a person diagnosed with leukemia and needing a bone marrow transplant?
- (A) father
  - (B) fraternal twin
  - (C) identical twin
  - (D) mother
35. What is the most likely effect if the production of HCG stops during the first month of a high risk pregnancy?
- (A) oxytocin decreases
  - (B) oxytocin increases
  - (C) progesterone decreases
  - (D) progesterone increases
36. Which refers to the genetic composition of an organism?
- (A) allele
  - (B) genotype
  - (C) phenotype
  - (D) trait

37. How many different kinds of gametes can normally be produced by an organism with the genotype RrYy?
- (A) 1  
(B) 2  
(C) 3  
(D) 4
38. Mendel stated that units of inheritance may be inherited independently. Which best restates this conclusion in modern terms?
- (A) During fertilization, which sperm combines with which egg is a matter of chance.  
(B) In mitosis, there is no difference between the original DNA molecule and its replicated copy.  
(C) In the first stage of meiosis, chromosomes pair with their homologues.  
(D) In the first stage of meiosis, the segregation of one pair of chromosomes does not affect the segregation of other chromosomes.
39. Which is a test cross?
- (A) AA × Aa  
(B) Aa × Aa  
(C) aa × aa  
(D) Aa × aa
40. A purebred red-flowered snapdragon is crossed with a purebred white-flowered snapdragon. If all the F<sub>1</sub> are pink what does this indicate about the alleles?
- (A) Pink is dominant.  
(B) Red and white are co-dominant.  
(C) Red and white are incompletely dominant.  
(D) Red is dominant.
41. Mr. and Mrs. Smith have blood types B and O. Four babies were tested and their blood types are listed below. Which baby or babies could belong to Mr. and Mrs. Smith?

Baby	Blood Type
1	B
2	A
3	AB
4	O

- (A) Baby 1 only  
(B) Baby 1 and Baby 4 only  
(C) Baby 2 and Baby 4 only  
(D) Baby 3 only
42. What is the chance that a couple will have four boys in a row?
- (A)  $\frac{1}{2}$   
(B)  $\frac{1}{8}$   
(C)  $\frac{1}{16}$   
(D)  $\frac{1}{32}$

43. Black coat color is dominant to white coat color in guinea pigs. If a heterozygous black guinea pig is mated with a white pig, what percentage of offspring should be black?
- (A) 0 %  
 (B) 25 %  
 (C) 50 %  
 (D) 100 %
44. *M. jalapa* plants with deep crimson flowers and *M. jalapa* plants with yellow flowers were studied. Cross-pollinating these plants produced plants with deep red flowers only ( $F_1$  generation). These  $F_1$  plants were allowed to self-pollinate, and the resulting seeds produced 450 deep red and 160 yellow *M. jalapa* plants. With respect to the alleles for flower color, what do these results indicate?
- (A) codominance  
 (B) complete dominance  
 (C) incomplete dominance  
 (D) X-linked inheritance
45. Some diseases, such as cystic fibrosis, can be inherited even if neither parent has the disease. What is the most likely cause of this?
- (A) dominant alleles  
 (B) environment  
 (C) recessive alleles  
 (D) weakened immune system
46. What was Rosalind Franklin's contribution to the discovery of DNA structure?
- (A) She isolated the agent behind the transforming principle.  
 (B) She made important discoveries about the properties of nucleic acids.  
 (C) She photographed DNA using X-rays.  
 (D) She produced a structural model of DNA.
47. Which describes the composition of a chromosome?
- (A) one very long DNA molecule  
 (B) one very long gene molecule  
 (C) thousands of protein molecules  
 (D) thousands of RNA molecules
48. Which structure below is represented by A?

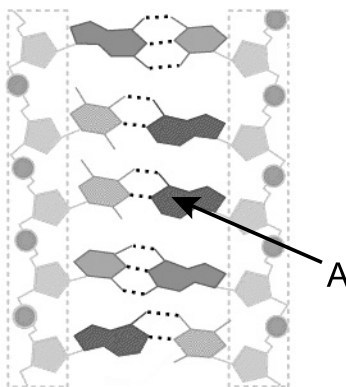

- (A) hydrogen bond  
 (B) nitrogen base  
 (C) phosphate  
 (D) sugar



49. Skin color in humans is an example of what type of inheritance?

- (A) incomplete dominance
- (B) multiple alleles
- (C) polygenic inheritance
- (D) sex-linked inheritance

50. Why are human females less likely to be color-blind than males?

- (A) Color blindness is linked to testosterone levels.
- (B) Color blindness is the dominant condition in males.
- (C) Human females have two X chromosomes.
- (D) The gene for color blindness is autosomal.

51. Which scientist discovered sex-linked inheritance?

- (A) Chargaff
- (B) McClintock
- (C) Morgan
- (D) Wilkins

52. Which describes genes carried on the same chromosome?

- (A) dominant
- (B) gene-linked
- (C) independently assorted
- (D) sex-linked

53. Which is an autosomal recessive genetic disease?

- (A) hemophilia
- (B) progeria
- (C) sickle cell anemia
- (D) Tay Sachs

54. What inheritance pattern is illustrated in the pedigree shown below?

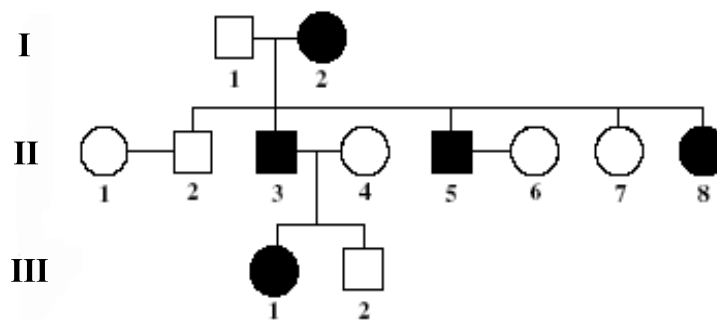

- (A) autosomal dominant
- (B) autosomal recessive
- (C) sex-linked dominant
- (D) sex-linked recessive

55. Which shape best resembles a model of mRNA?

- (A) comb
- (B) ladder
- (C) pyramid
- (D) spring

56. Which step in DNA replication involves the DNA unwinding and unzipping?
- (A) elongation  
 (B) initiation  
 (C) proofreading and correction  
 (D) termination
57. If the sequence of bases in one strand of DNA is GGC TAA, what is the sequence in the complementary strand?
- (A) AAT CGG  
 (B) CCG ATT  
 (C) GGC TAA  
 (D) TTU GCC

*Amino Acids coded by RNA Codons*

First Letter	Second Letter				Third Letter
	U	C	A	G	
U	phenylalanine	serine	tyrosine	cysteine	U
	phenylalanine	serine	tyrosine	cysteine	C
	leucine	serine	<b>STOP</b>	<b>STOP</b>	A
	leucine	serine	<b>STOP</b>	tryptophan	G
C	leucine	proline	histidine	arginine	U
	leucine	proline	histidine	arginine	C
	leucine	proline	glutamine	arginine	A
	leucine	proline	glutamine	arginine	G
A	isoleucine	threonine	asparagine	serine	U
	isoleucine	threonine	asparagine	serine	C
	isoleucine	threonine	lysine	arginine	A
	<b>START/ methionine</b>	threonine	lysine	arginine	G
G	valine	alanine	aspartate	glycine	U
	valine	alanine	aspartate	glycine	C
	valine	alanine	glutamate	glycine	A
	valine	alanine	glutamate	glycine	G

58. Using the RNA codon table above, which amino acids are coded by the DNA sequence GCT AAT?
- (A) alanine-valine  
 (B) arginine-leucine  
 (C) serine-proline  
 (D) valine-glycine

59. An anti-sense strand of DNA has bases ATC GAT CCG. Which is the correct sequence for bases on tRNA anticodons coded from this DNA?
- (A) AUC GAU CCG  
 (B) TAG CTA GGC  
 (C) UAG CUA GGC  
 (D) CGG ATC GAT
60. Which type of mutation involves a part of one chromosome changing place with a part of another chromosome?
- (A) duplication  
 (B) inversion  
 (C) nondisjunction  
 (D) translocation
61. Which diagnostic technique enables direct observation of a developing fetus?
- (A) amniocentesis  
 (B) chorionic villi sampling  
 (C) fetoscopy  
 (D) genetic markers

62. Which chromosomal abnormality is shown in the karyotype below?



- (A) Down Syndrome  
 (B) Jacobs Syndrome  
 (C) Klinefelter Syndrome  
 (D) Turner Syndrome
63. Which technique allows for DNA fragments to be separated into bands forming a DNA fingerprint?
- (A) cloning  
 (B) DNA amplification  
 (C) DNA sequencing  
 (D) gel electrophoresis
64. Which technique is used to culture human stem cells for use in treating medical disorders?
- (A) differentiation  
 (B) gene therapy  
 (C) reproductive cloning  
 (D) therapeutic cloning

65. Which is the best example of natural selection?
- (A) changing frequencies of beak lengths in Costa Rican parrot populations since 1820
  - (B) development of various breeds of dogs
  - (C) reduction of genetic variability of the northern elephant seals as a result of bottlenecking
  - (D) spontaneous production of new plant species by the interbreeding of two parent species
66. Which scientist proposed that catastrophes eliminated local populations and allowed populations from nearby unaffected areas to repopulate the disaster area?
- (A) Cuvier
  - (B) Darwin
  - (C) Lyell
  - (D) Malthus
67. A paleontologist discovers two fossils in different geographical areas. There is similarity in the structure of the lower jaw in both fossils, and she concludes that the two organisms are related to each other. What is the basis of her conclusion?
- (A) biogeography
  - (B) comparative anatomy
  - (C) comparative embryology
  - (D) molecular biology
68. A rock that is 5 million years old contains 1/64 of the original amount of actinium-229. What is the half-life of actinium-229?
- (A) 21 834 years
  - (B) 78 125 years
  - (C) 833 333 years
  - (D) 2 500 000 years
69. If achondroplasia (dwarfism) is an autosomal dominant disorder, and occurs in one in 10 000 births, what frequency of the population is heterozygous?
- (A) 0.0001
  - (B) 0.0010
  - (C) 0.0198
  - (D) 0.9801
70. What would explain the fact that on the island portion of Newfoundland and Labrador, there is an abnormally high rate of psoriasis (a genetic skin disorder) in the population?
- (A) bottle neck effect
  - (B) founder effect
  - (C) genetic drift
  - (D) mutations
71. Which mechanism of evolution leads a population to evolve toward the extremes for a trait?
- (A) directional selection
  - (B) disruptive selection
  - (C) sexual selection
  - (D) stabilizing selection

72. A population of 1000 birds lives on an island. Some of the birds are green and some are yellow. Yellow is recessive. If a hurricane on the island kills most of the birds, which condition will result if the ten surviving birds are all yellow?
- (A) adaptive radiation
  - (B) bottle neck effect
  - (C) founder effect
  - (D) natural selection
73. Two species mate and the offspring are fertile and viable. These offspring then mate to produce infertile and weak offspring. Which describes this situation?
- (A) hybrid breakdown
  - (B) hybrid inviability
  - (C) hybrid sterility
  - (D) hybrid viability
74. In a particular area there are two species of birds where one species breeds during the night, and the other species breeds during the day. Which type of isolation describes this barrier to reproduction?
- (A) behavioural
  - (B) gametic
  - (C) habitat
  - (D) mechanical
75. Which theory suggests that life had its origins from sources outside the planet?
- (A) GAIA
  - (B) Miller-Urey
  - (C) Oparin-Haldene
  - (D) Panspermia

**PART II**  
**Total Value: 25%**

**Instructions: Complete all items in this section. Your responses should be clearly presented in a well-organized manner.**

**Value**

2% 76.(a) Neurotransmitter levels in the brain have been linked to clinical depression. What is the biological basis for this relationship?

---

---

---

---

---

---

---

---

---

---

3% (b) Explain how the nervous and endocrine systems work together when the body responds to a dangerous situation.

---

---

---

---

---

---

---

---

---

---

---

---

---

---

---

---

---

---

---

---

---

---

---

---

**Value**

3% 77.(a) A man has been diagnosed with prostate cancer and is about to undergo radiation treatments. He does not have any children but would like to have them in the future. Explain why having biological children could be difficult after undergoing these treatments and suggest two possible solutions.

---

---

---

---

---

---

---

---

---

---

---

---

---

---

---

---

---

---

---

---

---

---

---

2% (b) Recently, some couples have been “freezing” and storing umbilical cord and placental blood as a source of stem cells. Some argue that this service should be provided, free of charge, to all parents. Give two reasons to support this argument.

---

---

---

---

---

---

---

---

---

---

---

---

---

---

---

---

---

---

---

---

---

---

---

2% (c) A post-menopausal woman has been prescribed hormone replacement therapy which includes estrogen and progesterone. Give two reasons why maintaining a healthy lifestyle is especially important for this female.

---

---

---

---

---

---

---

---

---

---

---

---

---

---

---

---

---

---

---

---

---

---

---

**Value**

4% 78.(a) In corn plants, thick husk (T) is completely dominant to thin husk (t), and green seed (G) is completely dominant to yellow seed (g). Two thick husk green seed plants are crossed and one of the plants produced is thin husk and yellow. What percentage of the offspring share the same genotype as the parents? What is the phenotypic ratio of the plants produced? Show all workings.

3% (b) A mutation changed a DNA template sequence from AGC CCG GCA TTG to AGC CCG GGC ATT G.

i) What type of gene mutation caused this change?

---

---

ii) Using the codon table provided on page 10, show how the polypeptide sequence changes from the original to the mutated strand.



**Value**

2% 78.(c) The Human Genome Project has identified the DNA-base sequence of all human chromosomes. Describe how the scientific knowledge gained through the Human Genome Project presents both risk and benefit to society.

---

---

---

---

---

---

---

---

---

---

2% 79.(a) What ecological factor could have lead to speciation of the finch populations on each of the Galapagos Islands? Explain.

---

---

---

---

---

---

---

---

---

---

2% (b) The media has recently reported that a high number of patients, while staying in the hospital, are getting infections caused by antibiotic resistant bacteria. Using evolutionary theory, explain how this could occur.

---

---

---

---

---

---

---

---

---

---