

PART I
Total Value: 75%

Instructions: Shade the letter of the correct answer on the computer scorable answer sheet provided.

1. Which part of the nervous system is made up of the brain and spinal cord?
 (A) central
(B) parasympathetic
(C) peripheral
(D) sympathetic

2. Which structure protects the brain?
(A) hypothalamus
(B) medulla
 (C) meninges
(D) pons

3. Which structure directly controls a person's ability to think about a question and answer it correctly?

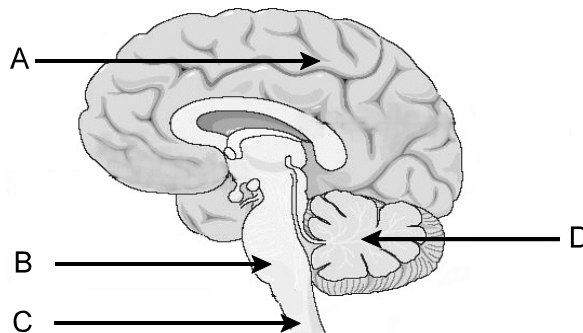

- (A) A
(B) B
(C) C
(D) D

4. Which describes the movement of ions by the sodium-potassium pump?
(A) less sodium out than potassium in
 (B) more sodium out than potassium in
(C) same sodium in as potassium out
(D) same sodium out as potassium in

5. What type of compounds are acetylcholine and dopamine?
(A) depressants
 (B) neurotransmitters
(C) poisonous drugs
(D) stimulants

6. A researcher used electrical stimulation of a neuron to cause a response in muscle tissue and collected the data below. What can be concluded from this experiment?

Electronic Stimuli (mV)	Muscle Response
10	none
20	none
30	none
40	contraction
50	contraction

	Stimulation	Response
✓ (A)	above threshold	contraction
(B)	above threshold	mild response
(C)	below threshold	contraction
(D)	below threshold	mild response

7. The diagram below shows portions of two neurons in a person's brain. If a stimulus has reached the synapse, which is most likely represented by X?

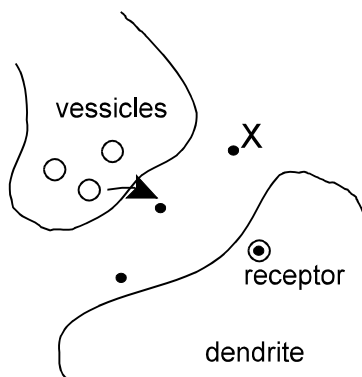

- ✓ (A) acetylcholine
 (B) cholinesterase
 (C) dopamine
 (D) norepinephrine
8. Which drug is classified as a depressant?
- ✓ (A) alcohol
 (B) caffeine
 (C) ecstasy
 (D) nicotine
9. What is the correct order of the path of light through the eye?
- (A) cornea → lens → vitreous humor → pupil → retina
 ✓ (B) cornea → pupil → lens → vitreous humor → retina
 (C) lens → pupil → cornea → vitreous humor → retina
 (D) retina → vitreous humor → lens → pupil → cornea

10. Which part of the eye contains rods and cones?

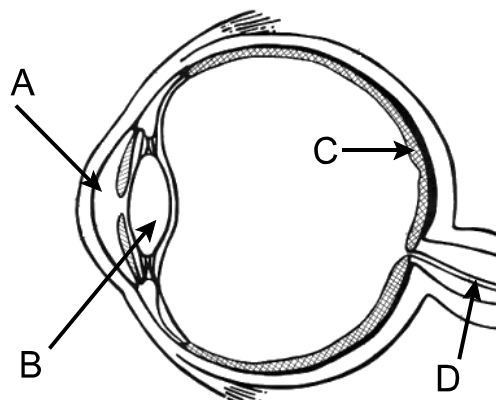

- (A) A
- (B) B
- ✓ (C) C
- (D) D

11. Which hormone is released from the pineal gland?

- (A) ADH
- (B) FSH
- ✓ (C) melatonin
- (D) oxytocin

12. When going through puberty, how does testosterone put hair on a boy's chest?

- (A) creates a second messenger
- (B) effects cells to change shape
- ✓ (C) interacts with DNA in the nuclei of cells
- (D) triggers nerve impulses in cells

13. Which hormones are produced in the adrenal gland?

- (A) ADH and FSH
- ✓ (B) aldosterone and cortisol
- (C) GH and GnRH
- (D) oxytocin and thymosin

14. What is the target organ for the hormone insulin?

- (A) adrenal cortex
- (B) heart
- (C) kidney
- ✓ (D) liver

15. A tumour detected on the thyroid gland inhibits thyroid function. What is the effect on thyroxin and thyroid-stimulating hormone (TSH)?

	Thyroxin	TSH
✓ (A)	low	high
(B)	low	low
(C)	high	high
(D)	high	low

16. What are chromatids?
- (A) bacterial chromosomes
 - (B) dense patches within the nucleus
 - ✓ (C) duplicate copies of a chromosome
 - (D) prokaryotic nuclei
17. Why might a doctor suggest radiation as the best treatment option for a patient diagnosed with a localized cancerous tumour?
- (A) can be administered at home
 - (B) has no side effects
 - ✓ (C) is focused on the affected area only
 - (D) will affect all of the body cells
18. If the DNA per cell is measured during each stage of meiosis, which represents the ratio of DNA in prophase I to the DNA in prophase II?

	Prophase I	Prophase II
(A)	1	2
(B)	1	4
✓ (C)	2	1
(D)	4	1

19. What is true of a clone?
- (A) has different chromosome numbers
 - (B) is produced by meiosis
 - ✓ (C) is produced by mitosis
 - (D) results from sexual reproduction
20. How are human sperm and eggs similar?
- (A) both are produced in equal numbers
 - (B) both are the same size
 - (C) both have motility
 - ✓ (D) both have the same number of chromosomes
21. Why might stem cells have the potential to decrease Parkinson's symptoms?
- ✓ (A) They can become neurons that produce dopamine in the brain.
 - (B) They cause existing brain cells to produce dopamine.
 - (C) They decrease the amount of dopamine reducing enzymes.
 - (D) They increase the effectiveness of dopamine receptors in the brain.
22. In which part of the flower does both meiosis and fertilization occur?
- (A) anther
 - (B) filament
 - ✓ (C) ovule
 - (D) stigma

23. Where are sperm produced?

- (A) interstitial cells
- (B) pituitary gland
- ✓ (C) seminiferous tubules
- (D) testes wall

24. Which structure is surgically altered by a vasectomy?

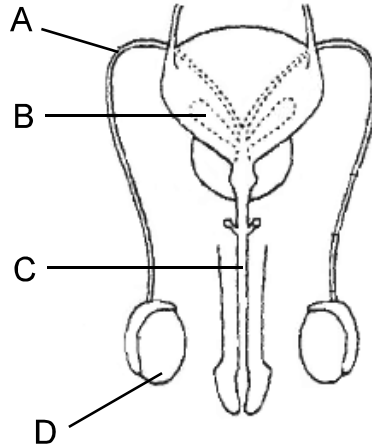

- ✓ (A) A
- (B) B
- (C) C
- (D) D

25. Which structure is affected by the secretion of progesterone?

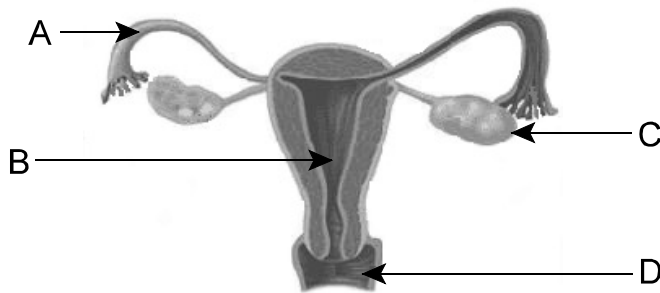

- (A) A
- ✓ (B) B
- (C) C
- (D) D

26. Which individual is in the follicular stage of the menstrual cycle?

Individual	Hormone	
	Progesterone	Estrogen
1	low	high
2	low	low
3	high	high
4	high	low

- ✓ (A) 1
- (B) 2
- (C) 3
- (D) 4

27. Which process occurs in the human female reproductive system?
- (A) external fertilization of gametes
 - (B) production of milk for the developing embryo
 - (C) production of zygotes in ovaries
 - ✓ (D) transport of oxygen through a placenta to a fetus
28. Which bacterial infection may not present symptoms at all or can lead to painful urination, penile or vaginal discharge?
- (A) AIDS
 - ✓ (B) chlamydia
 - (C) genital herpes
 - (D) hepatitis
29. A woman has blocked oviducts but produces healthy eggs. Which would allow her to conceive a child?
- (A) artificial insemination
 - (B) contraception
 - (C) cryopreservation
 - ✓ (D) in vitro fertilization
30. In which structure does gas exchange between the mother and fetus occur?

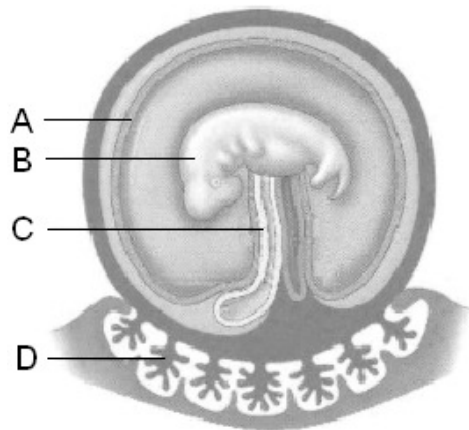

- (A) A
 - (B) B
 - (C) C
 - ✓ (D) D
31. Why might a man be infertile if he is exposed to toxic chemicals, radiation and has overheated testicles?
- ✓ (A) abnormal sperm production
 - (B) endometriosis
 - (C) obstructed oviduct
 - (D) obstructed vas deferens
32. What form of birth control is 100% effective?
- ✓ (A) abstinence
 - (B) birth control pill
 - (C) male condom
 - (D) rhythm method

33. Which structure does the allantois develop into?
- (A) amniotic fluid
 - (B) chorionic villi
 - (C) placenta
 - ✓ (D) umbilical cord blood vessels
34. A 42 year old woman, who is eight weeks pregnant, is concerned about the possibility of genetic abnormalities in the fetus and wants to be tested immediately. Which is the best technique to use?
- (A) amniocentesis
 - ✓ (B) chorionic villi sampling
 - (C) fetoscopy
 - (D) ultrasound
35. Which structure produces the navel (belly button)?
- (A) afterbirth
 - (B) amniotic sac
 - (C) placenta
 - ✓ (D) umbilical cord
36. Which are alternate forms of genes?
- ✓ (A) alleles
 - (B) chromatids
 - (C) hybrids
 - (D) sub units
37. How did Mendel obtain the F₁ generation of all hybrid tall pea plants?
- (A) hybrid tall × hybrid tall
 - (B) hybrid tall × pure tall
 - (C) pure short × pure short
 - ✓ (D) pure tall × pure short
38. Eye colour for fruit flies is determined by genes X, Y and Z. Which is illustrated if X produces black eyes, Y produces brown eyes and Z produces magenta (purple) eyes?
- (A) co-dominance
 - (B) incomplete dominance
 - ✓ (C) multiple alleles
 - (D) polygenic inheritance
39. Which type of inheritance causes variation in height and skin colour in humans?
- (A) co-dominance
 - (B) incomplete dominance
 - (C) multiple alleles
 - ✓ (D) polygenic inheritance

40. What is the probability of parents having the following three children: two boys in a row followed by a daughter?
- (A) $\frac{1}{16}$
 - ✓ (B) $\frac{1}{8}$
 - (C) $\frac{1}{4}$
 - (D) $\frac{1}{2}$
41. Which explains how a cross between two grey mice can produce black mice, grey mice and white mice?
- (A) Crossing over occurs between white and black alleles.
 - ✓ (B) Inheritance involves alleles that are incompletely dominant.
 - (C) Mutations occur during gamete formation.
 - (D) Non-disjunction results in the production of abnormal offspring.
42. What is one of Morgan's major contributions to the field of genetics?
- (A) concept of codons
 - (B) double helix
 - (C) Law of Dominance
 - ✓ (D) sex-linked traits
43. What does the Law of Independent Assortment state?
- (A) Gene pairs always sort in the same order.
 - ✓ (B) Gene pairs sort randomly and independently from each other.
 - (C) One allele is always dominant.
 - (D) Sister chromatids separate during gamete formation.
44. Where does crossing over occur?
- (A) anaphase of mitosis
 - (B) anaphase II of meiosis
 - (C) prophase of mitosis
 - ✓ (D) prophase I of meiosis
45. A baby boy inherits a recessive allele from his mother. In which circumstance would he most likely show the trait coded for by the recessive allele?
- (A) The allele is on an autosomal chromosome.
 - ✓ (B) The allele is on the X chromosome.
 - (C) The allele is on the Y chromosome.
 - (D) The allele undergoes a mutation.
46. What percent of guanine would be found in a strand of DNA containing 28% cytosine?
- (A) 22%
 - ✓ (B) 28%
 - (C) 44%
 - (D) 56%

47. What are the components of DNA?
- ✓ (A) phosphate group, nitrogenous base, deoxyribose sugar
 - (B) phosphate group, nitrogenous base, ribose sugar
 - (C) phosphate group, polypeptides, deoxyribose sugar
 - (D) phosphate group, polypeptides, ribose sugar
48. Which is a function of DNA polymerase?
- (A) cleaves and unwinds the double helix
 - (B) joins Okazaki fragments together
 - ✓ (C) proofreads base pairing
 - (D) synthesizes an RNA primer to begin elongation

Use the diagram below to answer questions 49 and 50.

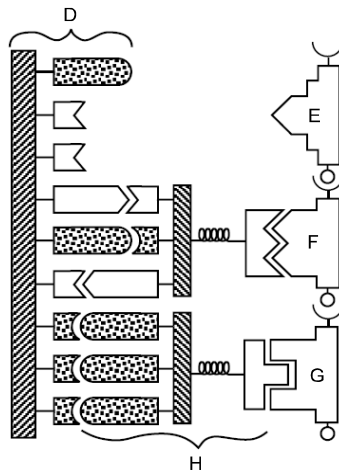

49. Which molecule acts as a template for the production of structure D?
- (A) amino acids
 - (B) dipeptides
 - ✓ (C) DNA
 - (D) RNA
50. What type of structure would be partially formed by molecules E, F and G?
- (A) DNA
 - ✓ (B) polypeptide
 - (C) polysaccharide
 - (D) RNA

Amino Acids coded by mRNA Codons

First Letter	Second Letter				Third Letter
	U	C	A	G	
U	phenylalanine	serine	tyrosine	cysteine	U
	phenylalanine	serine	tyrosine	cysteine	C
	leucine	serine	STOP	STOP	A
	leucine	serine	STOP	tryptophan	G
C	leucine	proline	histidine	arginine	U
	leucine	proline	histidine	arginine	C
	leucine	proline	glutamine	arginine	A
	leucine	proline	glutamine	arginine	G
A	isoleucine	threonine	asparagine	serine	U
	isoleucine	threonine	asparagine	serine	C
	isoleucine	threonine	lysine	arginine	A
	START/ methionine	threonine	lysine	arginine	G
G	valine	alanine	aspartate	glycine	U
	valine	alanine	aspartate	glycine	C
	valine	alanine	glutamate	glycine	A
	valine	alanine	glutamate	glycine	G

51. Using the codon table above, which DNA sequence was used as a template to produce the polypeptide sequence glycine - isoleucine - phenylalanine?

- (A) CCC TAG AAC
- ✓ (B) CCG TAA AAG
- (C) GGA TAC AAT
- (D) GGC TAT AAA

52. Which process is occurring in the diagram below?

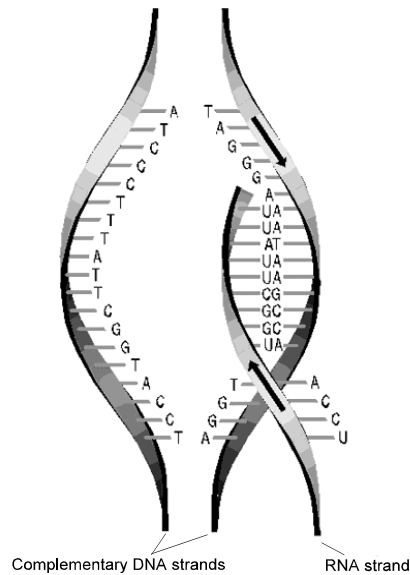

- (A) elongation
- (B) proofreading
- ✓ (C) transcription
- (D) translation

53. Which type of mutation results in no change to the phenotype?

- (A) mis-sense
- (B) nonsense
- ✓ (C) silent
- (D) translocation

54. What is the best explanation for the change shown in the diagram below?

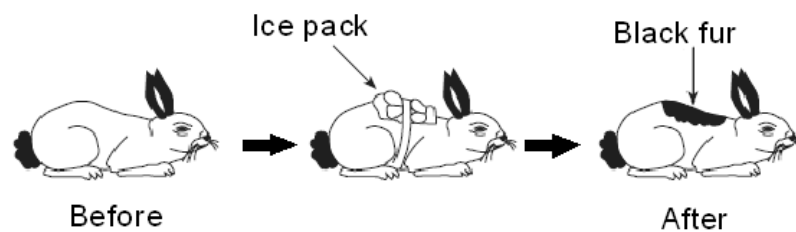

- (A) A mutation was caused by the cold temperature.
- (B) Cold temperature causes crossing over.
- (C) Sorting and recombination of genes can be affected by cold temperatures.
- ✓ (D) The environment can modify gene expression.

55. Which represents the situation below?

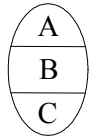
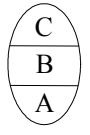
Mutation 1	Mutation 2
Normal DNA Strand <div style="border: 1px solid black; padding: 5px; display: inline-block;">AGT CGT AAG</div>	Normal Chromosome 
Abnormal DNA Strand <div style="border: 1px solid black; padding: 5px; display: inline-block;">AGT TCG AAG</div>	Abnormal Chromosome 

	More Severe	Amount of Genes Affected
(A)	Mutation 1	lower
(B)	Mutation 1	higher
(C)	Mutation 2	lower
✓ (D)	Mutation 2	higher

56. Which is an example of monosomy?

- (A) Down syndrome
- (B) Jacobs syndrome
- (C) Klinefelter syndrome
- ✓ (D) Turner syndrome

57. Which genetic disorder occurs through autosomal dominant inheritance?

- (A) albinism
- ✓ (B) Huntington's
- (C) sickle cell anemia
- (D) Tay-Sachs

58. Which could be the genotype of individual 1 in the pedigree shown below?

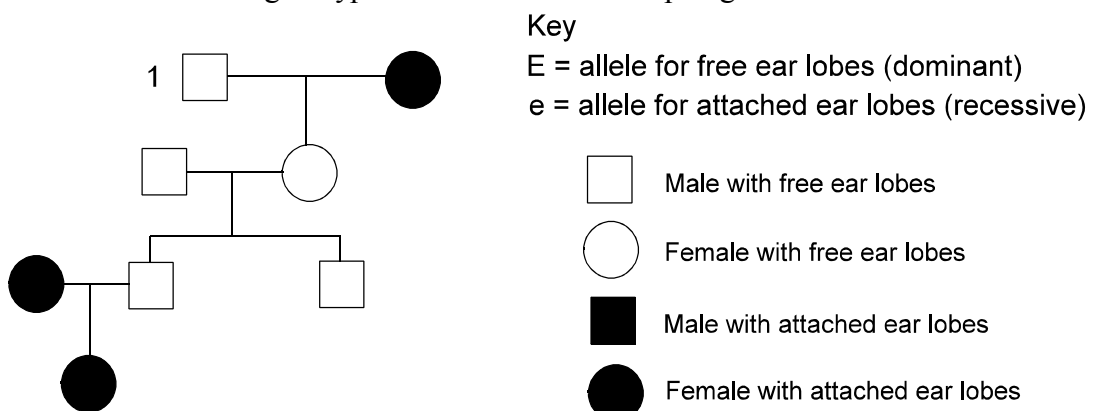

- (A) Ee only
- (B) EE only
- (C) Ee or ee
- ✓ (D) EE or Ee

59. The pedigree below traces the inheritance of a metabolic disorder. Affected individuals are indicated by the darkened circles (female) and squares (male). What is the pattern of inheritance for this disorder?

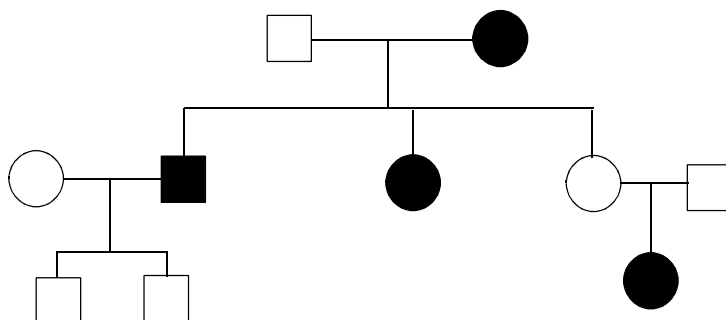

- (A) dominant allele
 (B) incomplete dominance
 ✓ (C) recessive allele
 (D) sex-linkage
60. What is the function of a restriction enzyme?
- (A) carry DNA to a new cell
 ✓ (B) cut DNA into many fragments
 (C) link together fragments of DNA
 (D) make numerous copies of a DNA segment
61. Along with restriction enzymes and gel electrophoresis, what is the minimum requirement necessary to perform a DNA fingerprint?
- ✓ (A) one sample of DNA, PCR amplification
 (B) one sample of DNA, recombinant DNA
 (C) two samples of DNA, PCR amplification
 (D) two samples of DNA, recombinant DNA
62. How can the technique shown in the diagram below be used to analyze a sample of DNA?

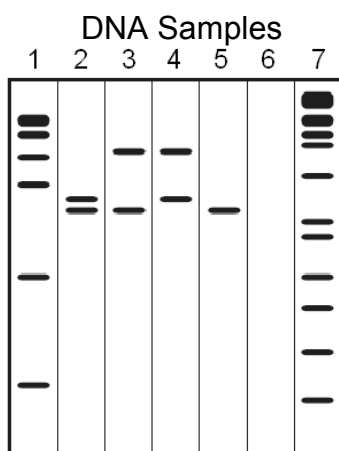

- (A) produces genetically engineered DNA molecules
 (B) removes the larger DNA fragments from the samples
 ✓ (C) separates DNA fragments on the basis of size
 (D) synthesizes large fragments of DNA
63. Which describes a transgenic organism?
- ✓ (A) contains a gene from another species
 (B) contains translocated genes
 (C) produced by a polymerase chain reaction
 (D) produced by cloning a mutant cell

64. Which characteristic would genetic engineers increase when trying to create a modified plant species?
- (A) fertilizer requirement
 - ✓ (B) resistance to pests
 - (C) susceptibility to herbicides
 - (D) water requirement
65. What is the meaning of the term “evolution”?
- (A) For every new species, an old one vanishes.
 - ✓ (B) Gradual changes in a species can occur through time.
 - (C) Immediate changes arise because of mutations.
 - (D) Species remain stable over a long period of time.
66. What must be done to observe the effects of natural selection on a population?
- (A) Human manipulation to obtain desired characteristics.
 - (B) Individuals must increase or decrease the use of some portion of their anatomy.
 - ✓ (C) One must observe more than one generation of the population.
 - (D) There must be the appearance of new species in the presence of existing species.
67. Which is an example of modern day natural selection?
- (A) analagous structures
 - (B) cloning
 - (C) comparative anatomy
 - ✓ (D) industrial melanism
68. Which statement is most directly associated with the research of Darwin?
- (A) Acquired characteristics are important for slow and gradual change in a population.
 - (B) Alleles located on chromosomes provide the means for variation in a population.
 - (C) Mutations are often harmful to a species.
 - ✓ (D) Organisms produce more offspring than can survive creating competition for resources.
69. Which explains that, over evolutionary time, many cave-dwelling animals have lost their eyes and whales have lost their hind limbs?
- (A) artificial selection
 - ✓ (B) Having these structures created disadvantages for the organisms.
 - (C) theory of use and disuse
 - (D) These organisms experienced harmful mutations.
70. Why do the embryos of animals like dogs, pigs and humans resemble one another in the early stages of development?
- ✓ (A) common ancestry
 - (B) same blood components
 - (C) similar habitat requirements
 - (D) similar number of chromosomes

71. Which describes the type of evolution of the two species of iguanas presented in the table below?

Species A	Species B
spends most of its time in the ocean	spends most of its time on land
is rarely found more than 10 m from shore	is found many meters inland from shore
eats algae	eats cactus and other land plants

- (A) coevolution
 (B) convergence
 ✓ (C) divergence
 (D) gene flow
72. What is illustrated by the fact that some hormones in humans are similar to those in pigs?
- ✓ (A) biochemical similarity
 (B) embryonic similarity
 (C) genetic variability
 (D) homologous organs
73. In a population, 9% of individuals are homozygous dominant for tongue rolling. What percentage of individuals are heterozygous for tongue rolling?
- (A) 30%
 ✓ (B) 42%
 (C) 70%
 (D) 91%
74. Which is a pre-zygotic barrier?
- (A) adaptive radiation
 ✓ (B) behavioural isolation
 (C) hybrid breakdown
 (D) hybrid inviability
75. The diagram below represents evolutionary pathways for two organisms. Which species was the most successful in the environment over time?

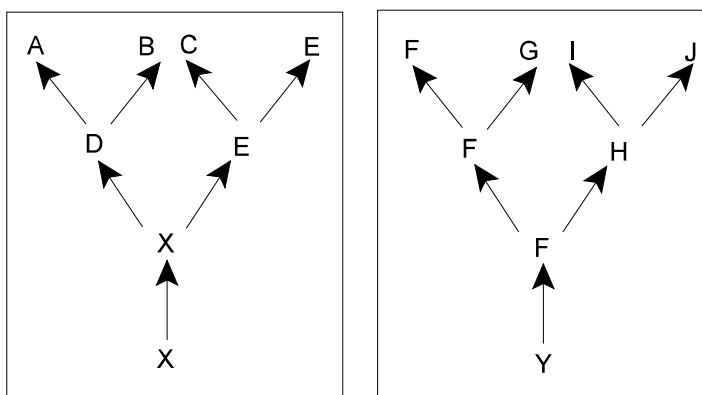

- (A) E
 ✓ (B) F
 (C) X
 (D) Y

PART II
Total Value: 25%

Instructions: Complete all items in this section. Your responses should be clearly presented in a well-organized manner.

Value

2% 76.(a) Describe one advantage and one disadvantage of a reflex arc response as compared to a normal response from the brain.

Advantage:

- quick

- removal from danger

- automatic

Disadvantage:

- may react inappropriately for the situation

- over-reaction

[1% awarded for one advantage, 1% awarded for one disadvantage]

3% (b) A researcher surgically removes the Islets cells from a rat's pancreas to observe the effects.

i) Describe two symptoms the rat should start exhibiting after the surgery.

- thirsty

- tiredness

- frequent urination

- inability to store sugar

- loss/deterioration of vision

[2% awarded for any two symptoms]

ii) Explain one way the researcher could treat these symptoms.

- give insulin

- surgery

- diet and exercise

[1% for any of these possible solutions]

Value

3% 77.(a) Graph 1 below shows the hormone levels present in a female over 28 days.

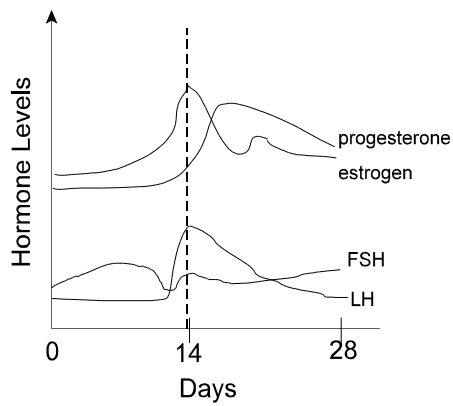

Graph 1

- i) Explain two ways to cause the changes in hormone levels observed below in Graph 2.

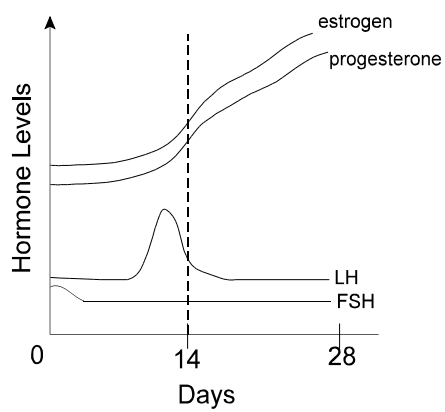

Graph 2

- pregnancy

- oral contraceptive

- depo-provera

[½% awarded for each of 2 possible causes; ½% awarded for explanation of each cause given.]

- ii) Compare the roles of follicle stimulating hormone (FSH) in men and women.

- In females, FSH cause follicles to mature an ovum.

- In males, FSH stimulates sperm production.

[½% each for the male and the female]

Value

4% 77.(b) A female patient is diagnosed with cancer and has to undergo both chemotherapy and radiation.

- i) Explain the effects of chemotherapy on the cellular processes of mitosis and meiosis.

- In mitosis, chemotherapy will prevent cell division which is why it will stop the growth of cancerous cells.

- In meiosis, chemotherapy will also prevent cell division.

[1% awarded for discussing the effects on mitosis, 1% awarded for discussing the effects on meiosis]

- ii) Explain the effects of radiation on the cellular processes of mitosis and meiosis.

- In mitosis, radiation will only affect the area being irradiated. It may cause mutations in that area.

- In meiosis, radiation may cause sterility if the area of irradiation is in close proximity to the genitals. Can cause mutations in germ cells which can cause problems with offspring.

[1% awarded for discussing the effects on mitosis, 1% awarded for discussing the effects on meiosis]

3% 78.(a) In humans, hemophilia is a sex-linked trait where normal clotting (H) is dominant and hemophilia (h) is recessive. Tongue rolling (T) is dominant to non-rolling (t). A non-hemophiliac male and a hemophiliac female produce a child. Both the male and the female are heterozygous for tongue rolling. What is the probability of this child being a hemophiliac who is a tongue roller?

$X^H Y T t$ crossed with $X^h X^h T t$

	$X^H T$	$X^h t$	$Y T$	$Y t$
$X^h T$	$X^H X^h T T$	$X^H X^h T t$	$X^h Y T T$	$X^h Y T t$
$X^h t$	$X^H X^h T t$	$X^H X^h t t$	$X^h Y T t$	$X^h Y t t$

3/8 of children will be hemophiliac tongue rollers. 37.5% chance.

[½% awarded for identifying each parents' genotype. 1% awarded for correctly carrying out the cross (Punnet Square or Product Rule). 1% awarded for finding the correct fraction or percentage of offspring who will be hemophiliac tongue rollers]

Value

3% 78.(b) In the production of sperm cells, a nondisjunction event occurred with the sex chromosomes during meiosis II.

- i) Using the diagram below, outline a possible distribution of the sex chromosomes in the four sperm produced.

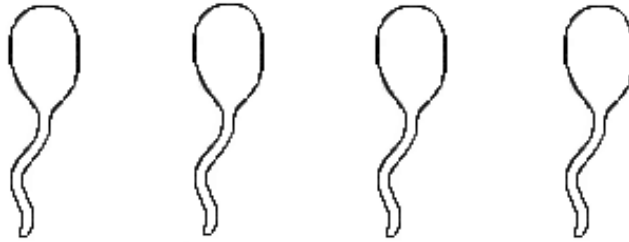

Many chromosomal distributions were possible. Some of the possibilities are:

Sperm Cell 1	Sperm Cell 2	Sperm Cell 3	Sperm Cell 4
XX	XY	YY	null
XX	null	Y	Y
X	X	YY	null
X	Y	XY	null

[½% awarded for each sperm cell completed with one of the possible sex cell chromosome distributions]

- ii) If the two affected sperm from this event fertilize two separate eggs, what two syndromes would be apparent in the offspring?

Trisomies could result in Klinefelter, Jacobs, or Triple X syndromes.

Monosomies could result in Turners syndrome.

***Common error was listing Downs as a possible result, however Down's is due to trisomy of autosomal chromosome 21.**

[½% awarded for each of one correct trisomy condition and one correct monosomy condition]

Value

3% 78.(c) Research has been done on the potential of changing the structure and function of human genetic material which is leading to improvements in medicine and health care for humans.

- i) Explain one way this knowledge has improved medicine and health care for humans.

- treatment of disease

- improved drug treatments

[1% awarded for one way knowledge has improved medicine]

- ii) Describe one reason why the application of this knowledge might affect an individual's privacy?

- Insurance coverage

- Job hiring

- Right to privacy

- Ethical reasons

[1% awarded for listing one effect on privacy, 1% awarded for a description of how the effect might be felt]

Value

2%

79.(a) Explain how the population of birds described below will change over time, and state a factor that might influence this change.

In birds, the ability to crush and eat seeds is related to the size, shape, and thickness of the beak. Birds with larger, thicker beaks are better adapted to crush and open seeds that are larger. One species of bird found in the Galapagos Islands is the medium ground finch. It is easier for most of the medium ground finches to pick up and crack open smaller seeds than larger seeds. When food is scarce, some of the birds have been observed eating larger seeds.

- Directional Selection toward larger beaks

OR

- Disruptional Selection leading to speciation

Competition is the primary factor which will influence change. Whether smaller

will be out-competed by larger birds with larger beaks of the same species, or

whether species with smaller beaks will be out-competed by species with

larger beaks.

*** Common error: a small bird will grow a larger beak within its lifetime.**

[1% awarded for how, 1% awarded for the factor influencing the change]

2%

(b) Due to the advanced development of antibiotics, scientists predicted that tuberculosis would be eradicated from the human population. Explain how, despite this prediction, there is now an increase of antibiotic resistant strains of tuberculosis.

- bacterial resistance

- mutations

- over-prescribing of antibiotics

- not taking the full prescription

[1% awarded for stating how the antibiotic strains may have come about,

1% awarded for an explanation of the process by which resistance might occur.]
