

PART I
Total Value: 75%

Instructions: Shade the letter of the correct answer on the computer scorable answer sheet provided.

1. Which structures in the diagram below belong to the central nervous system?

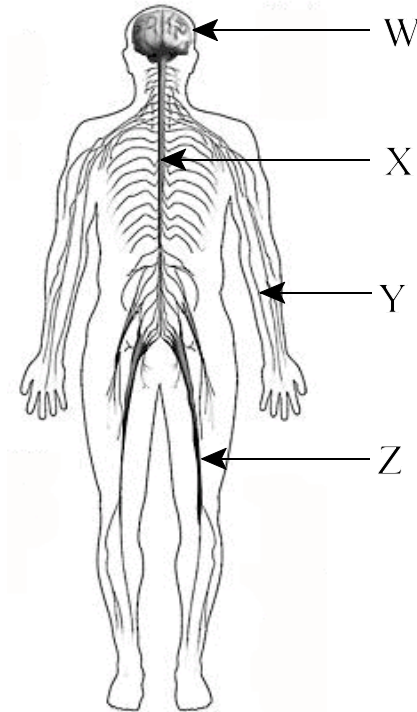

- (A) W and X
(B) W and Z
(C) Y and X
(D) Y and Z
2. If a person is unable to walk straight, which part of the brain is most likely damaged?

- (A) cerebellum
(B) cerebrum
(C) medulla
(D) thalamus

3. Which region of the brain below controls reflex actions, such as hiccuping and vomiting?

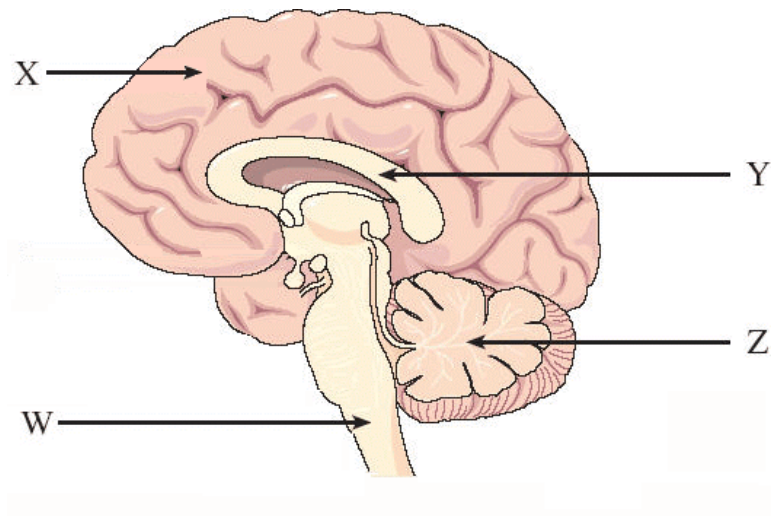

- (A) W
(B) X
(C) Y
(D) Z

4. Which best describes the response of a human's autonomic nervous system after an emergency situation?

	sympathetic	parasympathetic
(A)	inhibition	inhibition
(B)	inhibition	stimulation
(C)	stimulation	inhibition
(D)	stimulation	stimulation

5. Which part of a neuron is the site for receiving signals from other neurons?

- (A) axon
 (B) dendrite
 (C) myelin sheath
 (D) Schwann cells

6. What happens to the gates of the potassium ion (K^+) and sodium ion (Na^+) channels when a neuron is stimulated above its threshold?

	K^+ gates	Na^+ gates
(A)	close	close
(B)	close	open
(C)	open	close
(D)	open	open

7. In the diagram below an impulse travels from V to W but not from W to Y. Which best explains why there is no transmission from W to Y?

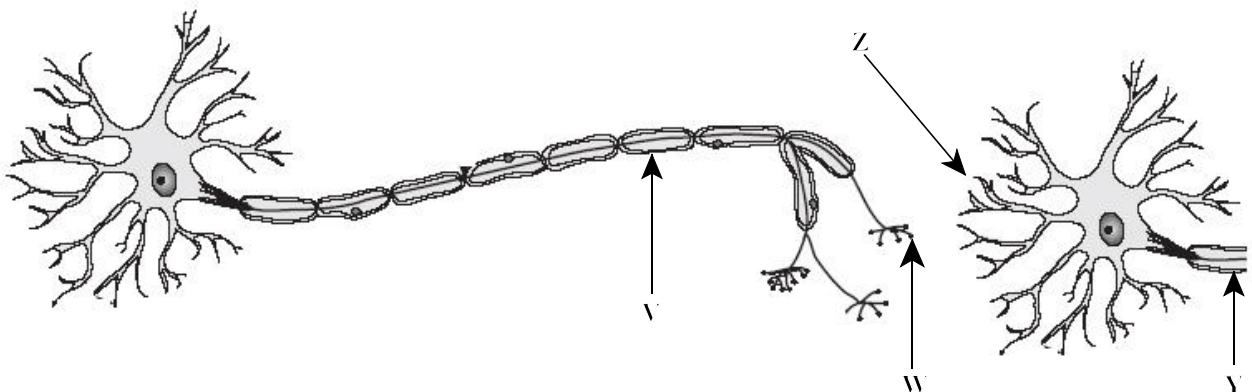

- (A) Acetylcholine caused an excitatory response at Z.
 (B) Acetylcholine caused an inhibitory response at Z.
 (C) Noradrenaline is inhibited at Y.
 (D) Noradrenaline is stimulated at Y.

8. What causes meningitis?

- (A) bacterial or viral infection
 (B) death of neurons that produce dopamine
 (C) degeneration of neurons in the brain
 (D) inflammation of the myelin sheath

9. Which is a depressant?
- (A) alcohol
(B) caffeine
(C) cocaine
(D) nicotine
10. What is the sequence through which light passes on its way to the retina of the human eye?
- (A) cornea → pupil → lens → retina
(B) cornea → lens → pupil → retina
(C) pupil → cornea → lens → retina
(D) pupil → lens → cornea → retina
11. Which part of the human ear is involved in hearing?
- (A) cochlea
(B) eustachian tube
(C) semicircular canals
(D) vestibule
12. Which gland controls calcium levels in blood?
- (A) adrenal
(B) pineal
(C) thymus
(D) thyroid
13. Dwarfism is caused by the under-secretion of which hormone?
- (A) adrenaline
(B) HGH
(C) LH
(D) thyroxine
14. The graph below shows the blood glucose levels of a healthy person over a short period of time. Which hormone is most likely secreted by the pancreas at point Y?

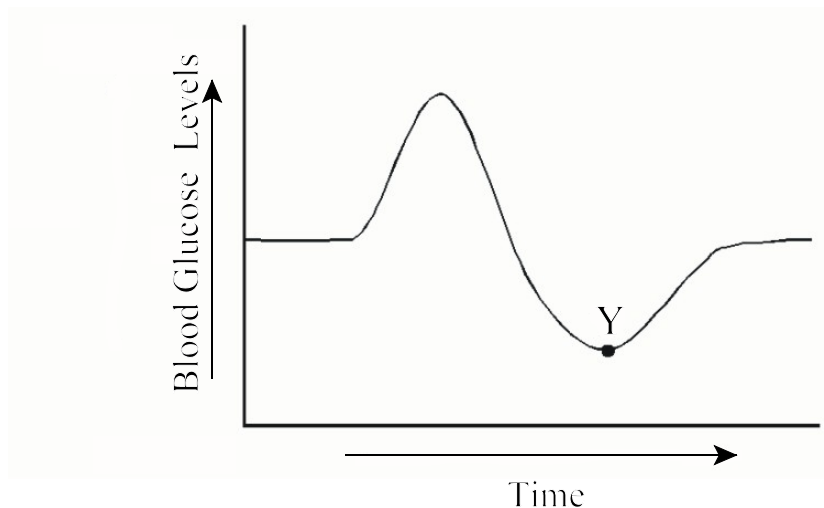

- (A) glucagon
(B) insulin
(C) melatonin
(D) somatotropin

15. Which is a result of hyperthyroidism?
- (A) decreased blood vessel diameter
 - (B) decreased mental capacity
 - (C) increased bone calcium
 - (D) increased metabolic rate
16. In which phase of mitosis do spindle fibres attach to the centromere of the replicated chromosomes?
- (A) anaphase
 - (B) metaphase
 - (C) prophase
 - (D) telophase

17. Which stage of mitosis is indicated in the diagram below?

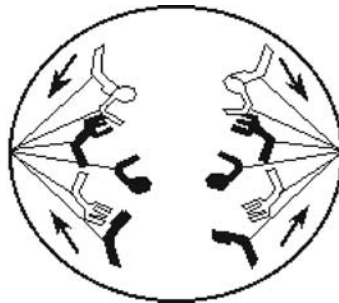

- (A) anaphase
 - (B) metaphase
 - (C) prophase
 - (D) telophase
18. Which type of cell division occurs only in reproductive organs?
- (A) cytokinesis
 - (B) meiosis
 - (C) mitosis
 - (D) mutation
19. What is the difference between the production of sperm and eggs in humans?
- (A) Eggs are produced by meiosis and sperm are produced by mitosis.
 - (B) Eggs are produced by mitosis and sperm are produced by meiosis.
 - (C) Females produce less eggs than males produce sperm.
 - (D) Females produce more eggs than males produce sperm.
20. How would a lack of mitochondria prevent fertilization?
- (A) The egg cell would be unable to penetrate the sperm cell.
 - (B) The egg cell would not have enough energy to reach the sperm cell.
 - (C) The sperm cell would be unable to penetrate the egg cell.
 - (D) The sperm cell would not have enough energy to reach the egg cell.
21. Why are stem cells used in medical research?
- (A) They differentiate into many types of cells.
 - (B) They differentiate into only one type of cell.
 - (C) They divide by meiosis.
 - (D) They divide by mitosis.

22. Which best describes sexual reproduction?

- (A) involves mitotic cell divisions
- (A) offspring are identical to parents
- (C) produces large numbers of offspring
- (D) promotes genetic diversity

23. Which type of asexual reproduction involves growing house plants from cuttings?

- (A) binary fission
- (B) budding
- (C) fragmentation
- (D) parthenogenesis

24. Which is a part of the female reproductive organ in flowering plants?

- (A) anther
- (B) pollen
- (C) stamen
- (D) stigma

25. During fertilization in flowering plants, how many sperm nuclei are required to form the zygote and endosperm?

	zygote	endosperm
(A)	1	1
(B)	1	2
(C)	2	1
(D)	2	2

26. What structure is labelled X in the diagram below?

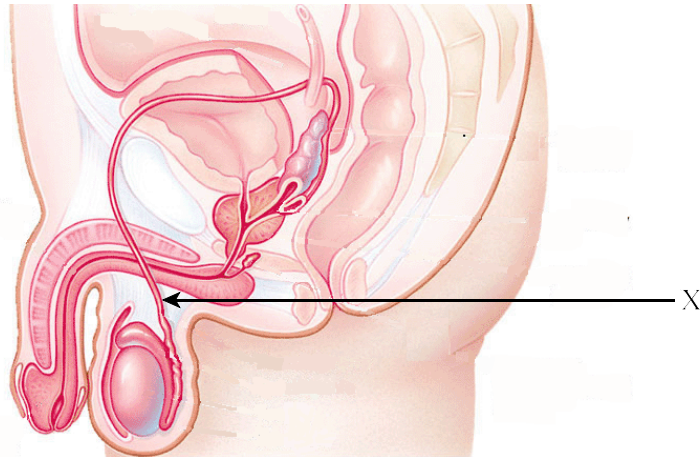

- (A) epididymis
- (B) prostate
- (C) urethra
- (D) vas deferens

27. Given normal body temperature is 37 °C, which temperature of the scrotum is best for producing healthy sperm in humans?

- (A) 30 °C
- (B) 35 °C
- (C) 40 °C
- (D) 45 °C

28. In which structure below does fertilization normally occur?

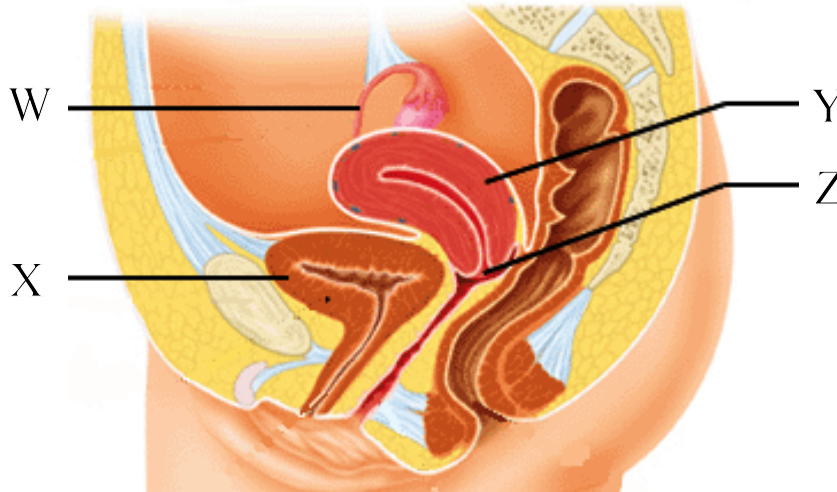

- (A) W
- (B) X
- (C) Y
- (D) Z

29. Which hormone stimulates spermatogenesis?

- (A) FSH
- (B) inhibin
- (C) progesterone
- (D) testosterone

30. The table below shows the relative levels of LH during the menstrual cycle. Which best describes what occurs on day 14?

Day	2	4	6	8	10	12	14	16	18	20	22	24	26	28
LH Level	7	4	2	5	16	45	29	9	9	7	4	2	4	8

- (A) A secondary oocyte deteriorates.
- (B) A secondary oocyte develops and grows.
- (C) The corpus luteum deteriorates.
- (D) The corpus luteum develops and grows.

31. A couple has been unsuccessful with having children because the female is unable to carry a child to term. Which is the best technological solution for this problem?

- (A) artificial insemination
- (B) *in vitro* fertilization
- (C) *in vitro* maturation
- (D) surrogate motherhood

32. Which method of birth control prevents the spread of sexually transmitted infections?
- (A) condom
 - (B) intrauterine device
 - (C) morning after pill
 - (D) vasectomy

33. Which process is represented by A in the diagram below?

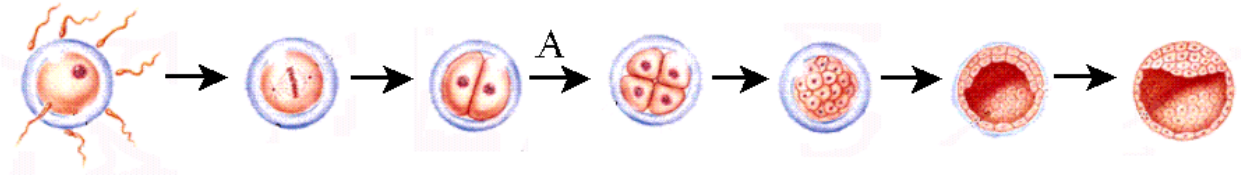

- (A) blastulation
 - (B) cleavage
 - (C) gastrulation
 - (D) meiosis
34. What is the function of structure X in the diagram below?

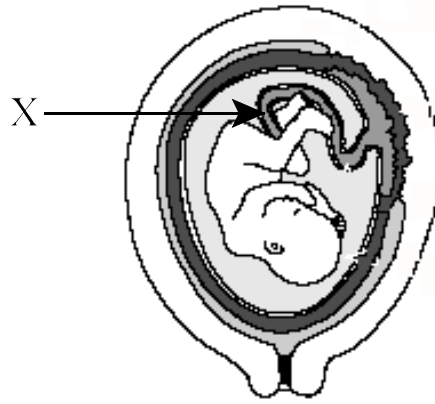

- (A) cushions the embryo
 - (B) nutrient exchange
 - (C) stimulates labour
 - (D) stores waste
35. Which is the correct order for the stages of childbirth?
- (A) dilation → expulsion → placental
 - (B) dilation → placental → expulsion
 - (C) placental → dilation → expulsion
 - (D) placental → expulsion → dilation
36. What is an allele?
- (A) alternate form of a chromosome
 - (B) alternate form of a gene
 - (C) DNA base
 - (D) RNA base

37. Which genotype(s) express a dominant trait?
- (A) tt and Tt
 - (B) tt only
 - (C) TT and Tt
 - (D) TT only
38. Black fur (B) is dominant to yellow fur (b) in Labrador retrievers. A black retriever crossed with a yellow retriever produced three black and three yellow puppies. What are the probable genotypes of the parents?
- (A) BB and BB
 - (B) BB and bb
 - (C) Bb and Bb
 - (D) Bb and bb
39. In a cross involving $AaBB \times AABb$, what is the probability of producing the genotype $AaBb$ in the offspring?
- (A) 1/8
 - (B) 1/4
 - (C) 1/3
 - (D) 1/2
40. What is the probability that an expecting couple with three girls will have another girl?
- (A) 1/16
 - (B) 1/4
 - (C) 1/2
 - (D) 3/4
41. What are possible blood types of a couple that produced children with blood types A, B, and O?
- (A) A and AB
 - (B) A and B
 - (C) O and AB
 - (D) O and B
42. Which type of trait is skin color?
- (A) complete
 - (B) incomplete
 - (C) monogenic
 - (D) polygenic
43. What is the chance that a male inherits his X chromosome from his mother?
- (A) 0%
 - (B) 25%
 - (C) 50%
 - (D) 100%

44. Eye color is an X-linked trait in fruit flies. If red eye color is dominant and white eye color is recessive, which are possible phenotypes for the parents if 100% of the male offspring have white eyes?

	mother	father
(A)	heterozygous white	red
(B)	heterozygous white	white
(C)	homozygous red	red
(D)	homozygous white	white

45. Which genetic researcher isolated two types of nucleic acids?

- (A) Levene
- (B) McClintock
- (C) Mendel
- (D) Watson

46. Whose work led to the Law of Segregation?

- (A) Griffith
- (B) Mendel
- (C) Morgan
- (D) Sutton

47. What does X represent in the diagram below?

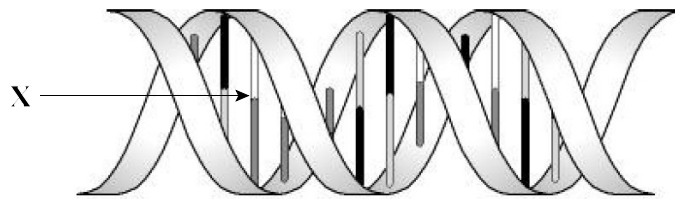

- (A) base pairs
 - (B) deoxyribose
 - (C) phosphates
 - (D) ribose
48. In which step of DNA replication does the molecule unwind and unzip?
- (A) elongation
 - (B) initiation
 - (C) proofreading
 - (D) termination
49. How many amino acids does a codon represent?
- (A) 1
 - (B) 2
 - (C) 3
 - (D) 4

Refer to the diagram below to answer the next two questions.

Amino Acids coded by RNA Codons

First Letter	Second Letter				Third Letter
	U	C	A	G	
U	phenylalanine	serine	tyrosine	cysteine	U
	phenylalanine	serine	tyrosine	cysteine	C
	leucine	serine	STOP	STOP	A
	leucine	serine	STOP	tryptophan	G
C	leucine	proline	histidine	arginine	U
	leucine	proline	histidine	arginine	C
	leucine	proline	glutamine	arginine	A
	leucine	proline	glutamine	arginine	G
A	isoleucine	threonine	asparagine	serine	U
	isoleucine	threonine	asparagine	serine	C
	isoleucine	threonine	lysine	arginine	A
	START/ methionine	threonine	lysine	arginine	G
G	valine	alanine	aspartate	glycine	U
	valine	alanine	aspartate	glycine	C
	valine	alanine	glutamate	glycine	A
	valine	alanine	glutamate	glycine	G

50. Which sequence on a DNA strand corresponds to the first amino acid inserted into a protein?
- (A) ATG
 (B) AUG
 (C) TAC
 (D) UAC
51. If the amino acid sequence below is produced, what would be the corresponding DNA sequence?
 cysteine - tryptophan - proline - glycine
- (A) ACA ACC GGC CCC
 (B) ACA ACT GAA TAG
 (C) ACG ACC GGG TAC
 (D) ACG ACT GCG GAG
52. Which point mutation results in slightly altered but still functional proteins?
- (A) frame shift
 (B) mis-sense
 (C) nonsense
 (D) silent

53. Which chromosome in the diagram below shows deletion?

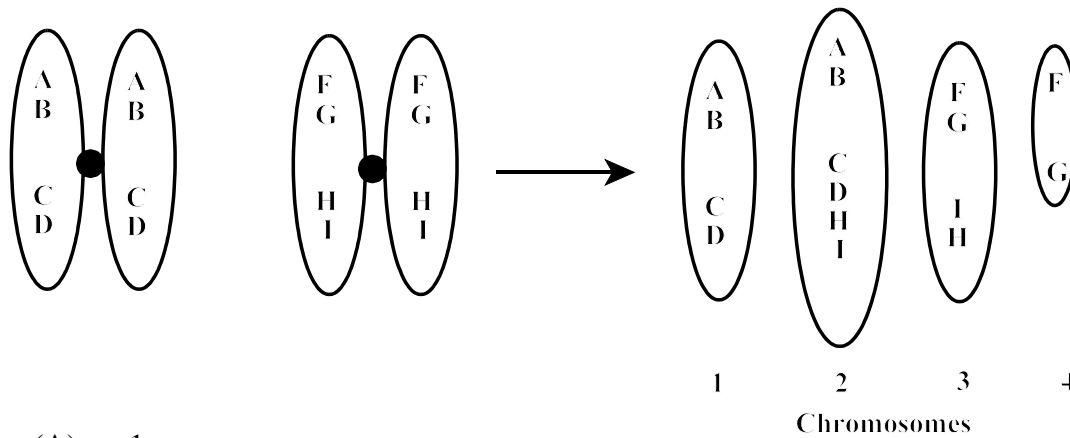

- (A) 1
- (B) 2
- (C) 3
- (D) 4

54. Which genetic syndrome is indicated by the karyotype below?



- (A) Down
- (B) Jacobs
- (C) Klinefelter
- (D) Turner

55. The percentage of urinary tract infections in young girls is much higher on the island of Newfoundland than mainland Canada. Which best explains this statement?

- (A) Mainland Canada has a founder population.
- (B) Mainland Canada has a large population.
- (C) The island of Newfoundland has a founder population.
- (D) The island of Newfoundland has a large population.

56. Which process is disrupted when ribosomes are disabled by antibiotics?

- (A) DNA replication
- (B) RNA replication
- (C) transcription
- (D) translation

57. The pedigree below shows the blood types of individuals. What is the chance that child X will have blood type AB?

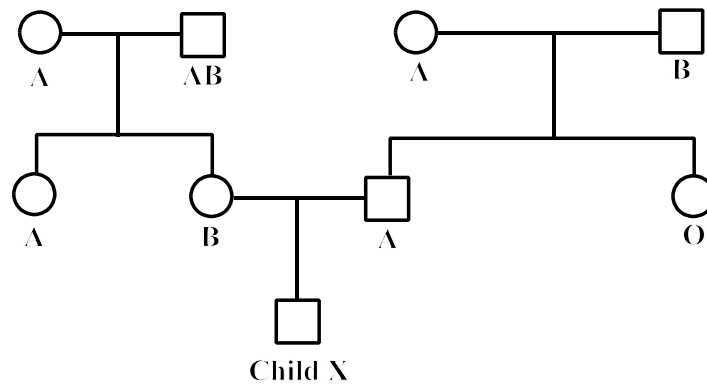

- (A) 0%
 (B) 25%
 (C) 50%
 (D) 100%
58. Which genetic disease is caused by an autosomal recessive allele?
- (A) Hemophilia
 (B) Muscular Dystrophy
 (C) Sickle Cell Anemia
 (D) Tay-Sachs
59. Who gathers information to determine the risk of a couple having children with a genetic disorder?
- (A) cytogeneticist
 (B) genetic counsellor
 (C) genetic engineer
 (D) medical geneticist
60. Which procedure involves inserting a long tube into the mother's abdomen in order to directly observe the developing child?
- (A) amniocentesis
 (B) CVS
 (C) fetoscopy
 (D) ultrasound
61. Which cuts DNA molecules at specific nucleotides?
- (A) cloning vectors
 (B) gel electrophoresis
 (C) genetic markers
 (D) restriction enzymes
62. Which is a potential benefit of cloning?
- (A) elimination of disease
 (B) embryo use and destruction
 (C) loss of individuality
 (D) reducing genetic variability

63. Which type of organism is produced by moving DNA from one organism to another?
- (A) clone
 - (B) hybrid
 - (C) polygenic
 - (D) transgenic
64. In the past five hundred years the flying squirrel population on an island has decreased dramatically. Which best explains why this occurred?
- (A) A new type of squirrel was introduced to the island.
 - (B) A structural change caused the squirrels to stop flying.
 - (C) Natural selection no longer favoured those who could fly.
 - (D) Young squirrels were not taught to fly by their parents.
65. Which scientist believed that a person who accidentally lost a finger would produce offspring with nine fingers?
- (A) Darwin
 - (B) Lamark
 - (C) Lyell
 - (D) Malthus

66. In which rock layer below would you expect to find the most recent and more complex organisms?

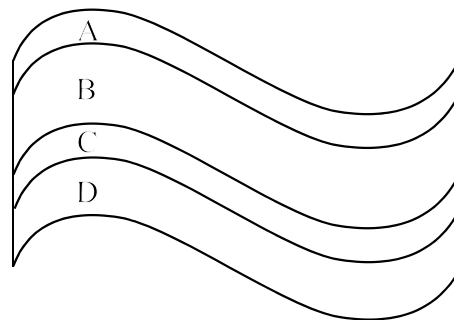

- (A) A
 - (B) B
 - (C) C
 - (D) D
67. Two alleles, A and a, are in Hardy-Weinberg equilibrium within a population. If the frequency of A is 0.7, what percentage of individuals show the dominant trait?
- (A) 30
 - (B) 49
 - (C) 70
 - (D) 91
68. The half-life of carbon-14 is 5730 years. How old is a fossil that contains 6.25 % of the original carbon-14?
- (A) 5730 years
 - (B) 11 460 years
 - (C) 17 190 years
 - (D) 22 920 years
69. What is the main mechanism for variation among organisms?
- (A) adaptation
 - (B) migration
 - (C) mutation
 - (D) speciation

70. Which type of structure provides evidence of a common evolutionary ancestor?

- (A) analogous
- (B) homologous
- (C) relative
- (D) vestigial

71. Cytochrome c is a protein found in mitochondria of most living organisms. Based on the information in the table below, which organism is most closely related to humans?

	Organism	Number of different amino acids in cytochrome c compared to humans
(A)	frog	15
(B)	lamprey	20
(C)	tuna	21
(D)	turtle	18

72. Which best illustrates geographic isolation?

- (A) caribou in Labrador and caribou in northern Quebec
- (B) fall-mating leopard frogs and spring-mating leopard frogs
- (C) moose in Labrador and moose on the island of Newfoundland
- (D) winter-mating red squirrels and summer-mating red squirrels

73. Some closely related insect species fail to achieve fertilization when they attempt to mate. Which biological barrier best explains why this happens?

- (A) hybrid inviability
- (B) hybrid sterility
- (C) mechanical isolation
- (D) temporal isolation

74. Which explains how Darwin's finches have similar body plans but increasingly different traits?

- (A) adaptive radiation
- (B) convergent evolution
- (C) homologous structures
- (D) vestigial structures

75. Which theory suggests that life originated elsewhere in the universe, and then migrated to our planet?

- (A) GAIA theory
- (B) Heterotroph hypothesis
- (C) Intelligent design
- (D) Panspermia theory

PART II
Total Value: 25%

Instructions: Complete all items in this section. Your responses must be clearly presented in a well-organized manner.

Value

3% 76.(a) Due to a mutation, the sodium binding site on a sodium potassium pump has changed such that it now binds with chloride ions (Cl^-). Sodium ions (Na^+) remain inside the membrane. What happens to nerve transmission? Give two reasons to justify your answer.

2% (b) Which endocrine gland is most likely damaged in a female whose menstrual cycle has stopped and metabolism has slowed? Explain.

Value

2% 77.(a) The diagram below shows a cell with two pairs of homologous chromosomes, (R_1 , R_2 and S_1 , S_2). Draw all possible daughter cells produced by the meiotic division of this cell and label the chromosomes in each daughter cell.

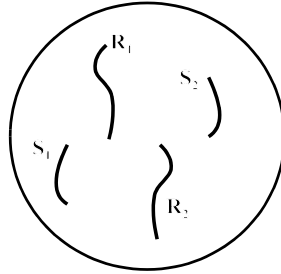

2% (b) Describe two ways in which the human population would most likely change if the only form of human reproduction was asexual?

2% (c) Give two reasons why birth control pills can be used to treat menopause.

Value

3% 78.(a) In guinea pigs, black hair (B) is dominant to white hair (b) and straight hair (S) is dominant to curly hair (s). Two guinea pigs are crossed. The male parent produces only one gamete, BS, and the genotypes of the offspring are BBSs and BbSs only. Determine the genotype and phenotype of each parent. Show your workings.

father's genotype: _____ mother's genotype: _____
father's phenotype: _____ mother's phenotype: _____

3% (b) The following mutation occurred.

original DNA strand: ACA TGA TCT ACC ATA TGG ...,
mutated DNA strand: ACA TGA TTA CCA TAT GG.....

- (i) What type of gene mutation caused this change? _____
- (ii) Explain two ways how this mutation affects the proteins produced?

Value

2% 78.(c) Explain two ways how the work done by Newfound Genomics is different from the work done by the Human Genome Project?

2% (d) How can genetic engineering be used to meet the increased demands of the human population for a low carbohydrate, high protein diet?

2% 79.(a) Explain, using evolutionary theory, why the scientific community is concerned about the increasing use of pesticides?

Value

2%

79.(b) Imagine that the first human mission to Mars was a tremendous success. A self-sustaining colony was established consisting of three females and six males, all of reproductive age. Give two reasons as to why this population would not remain in genetic equilibrium, according to the Hardy-Weinberg Principle.
